

KLIPPAN

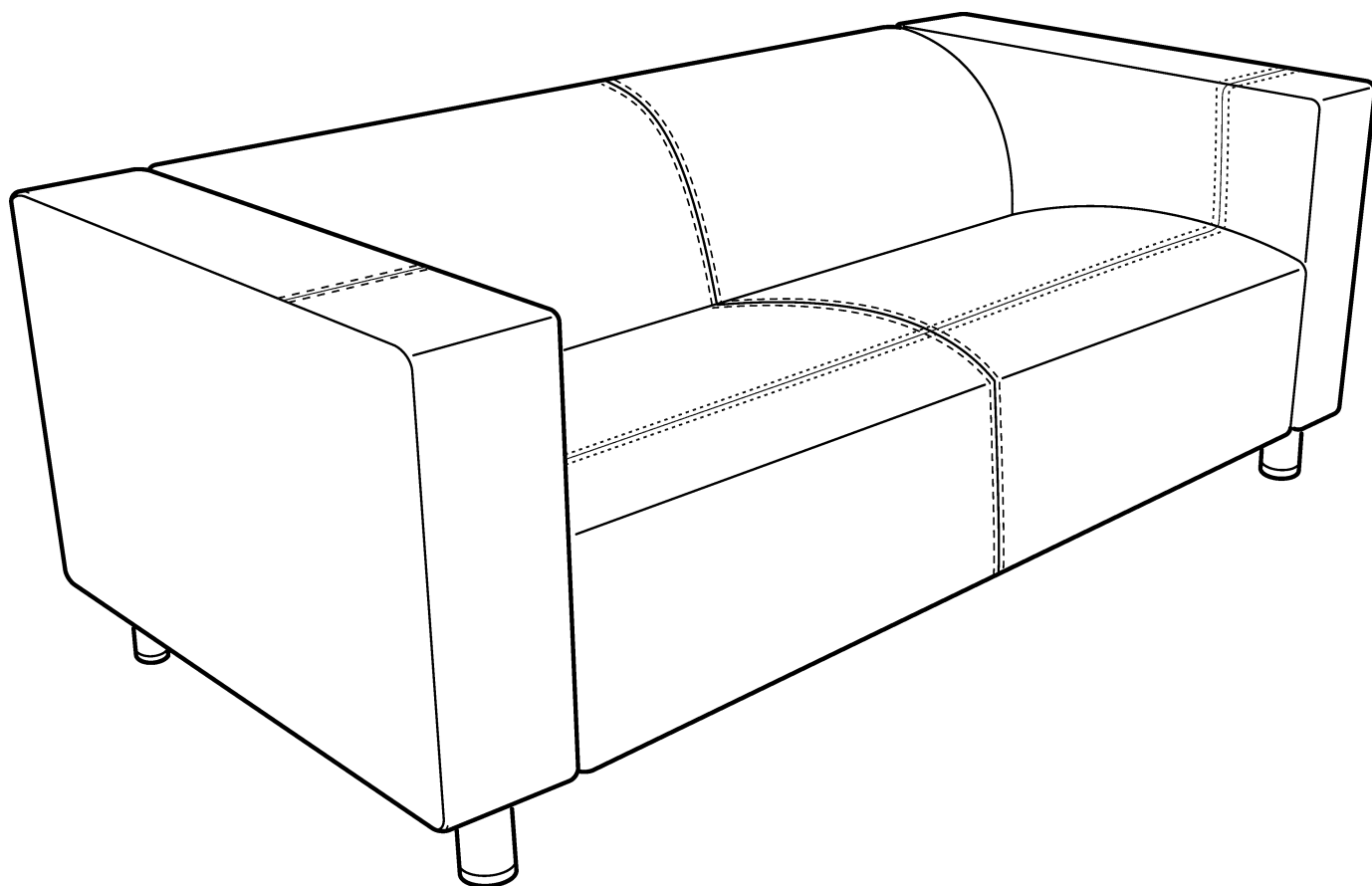

Design and Quality
IKEA of Sweden

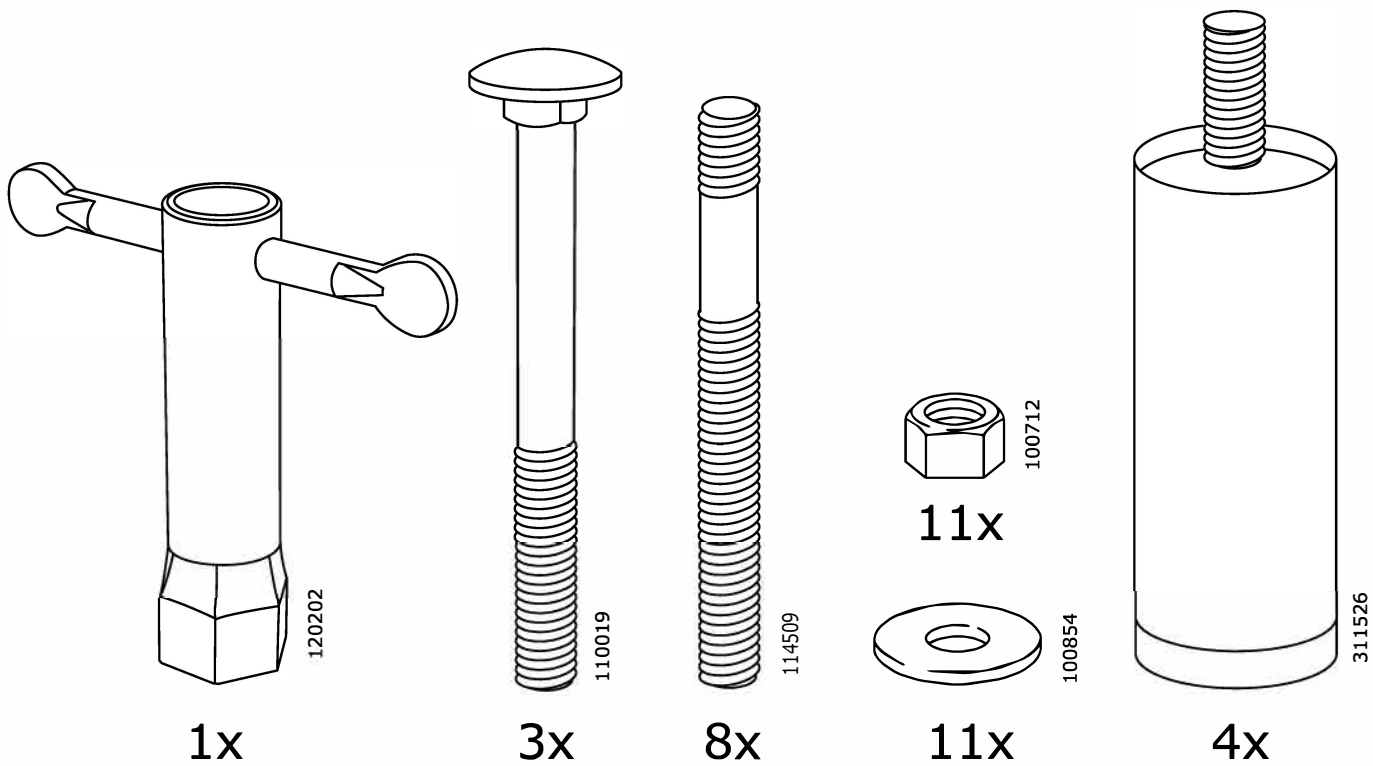
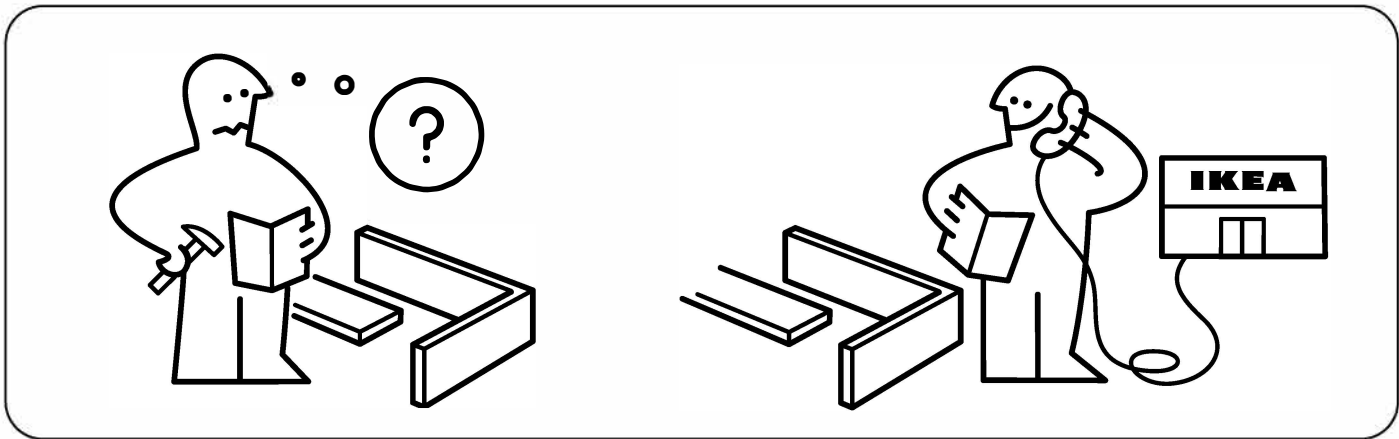
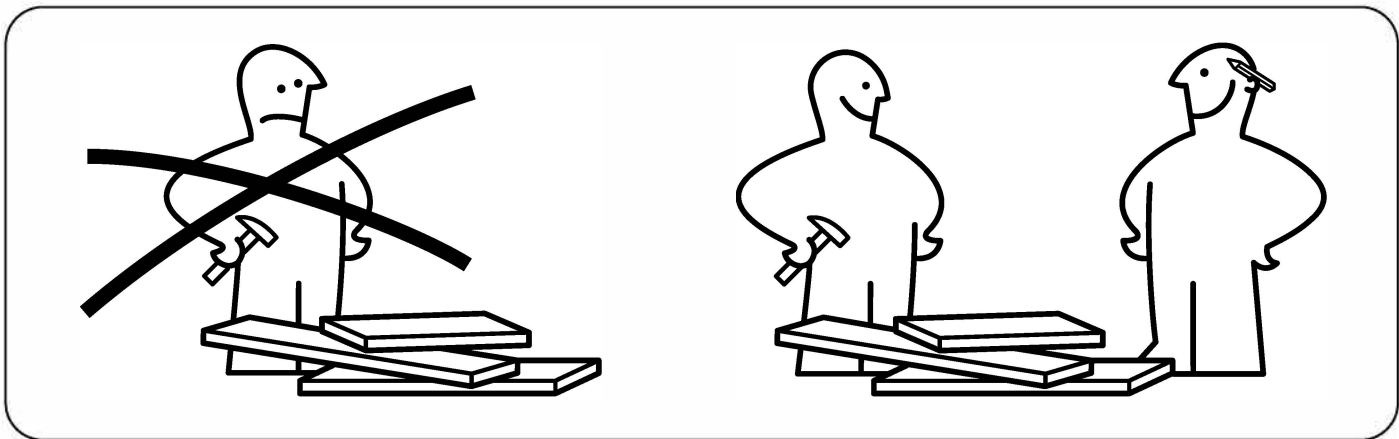

1

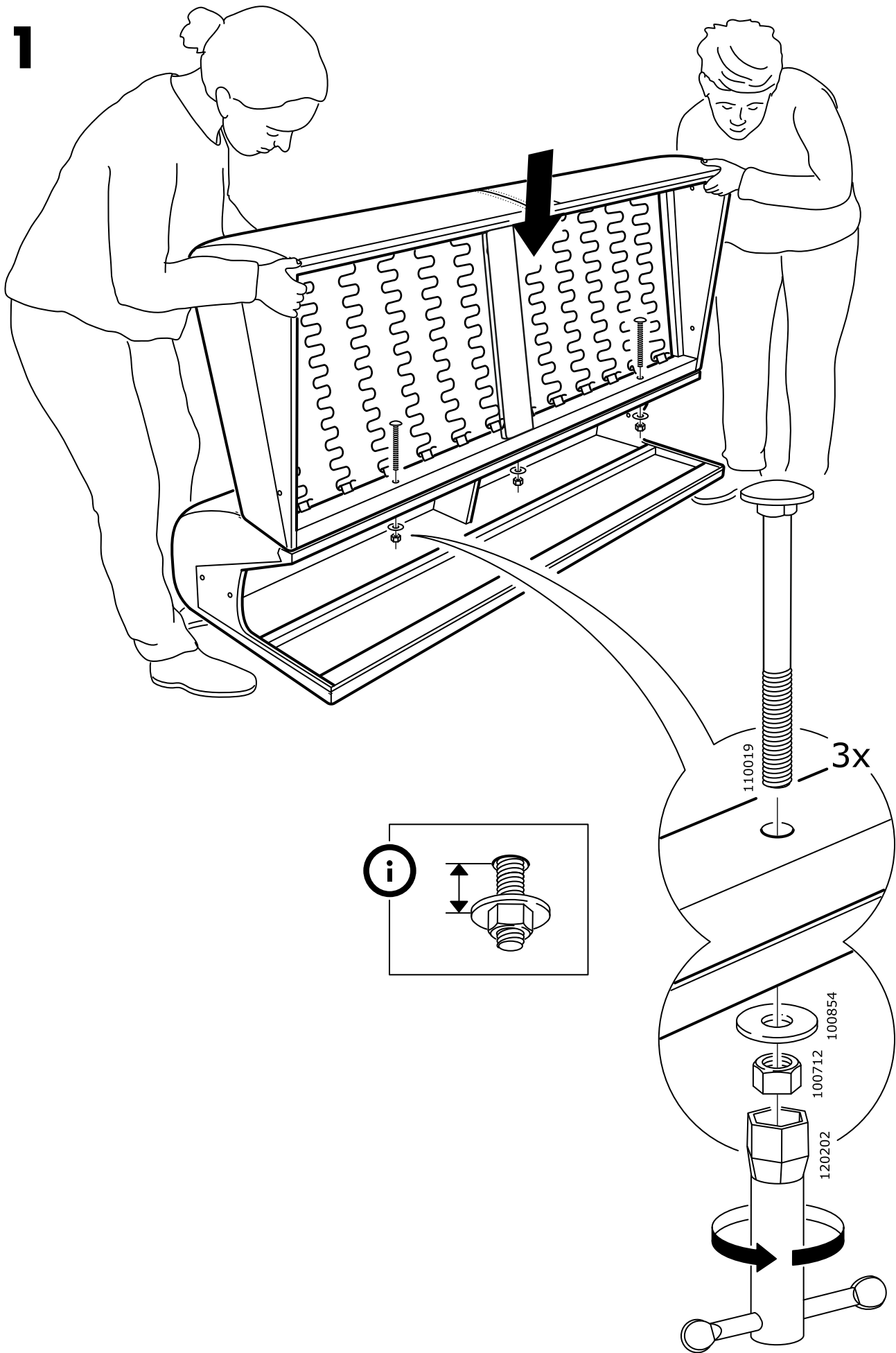

2

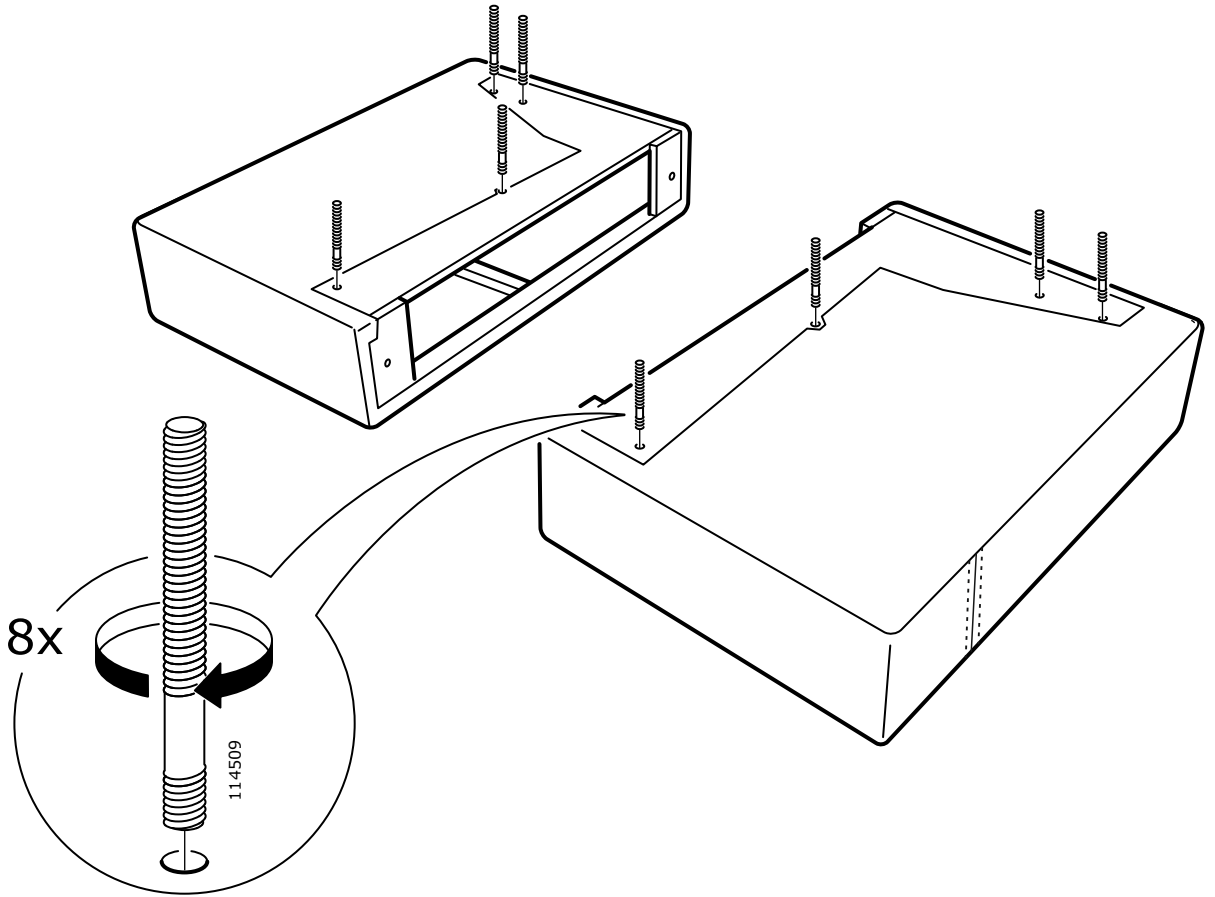

3

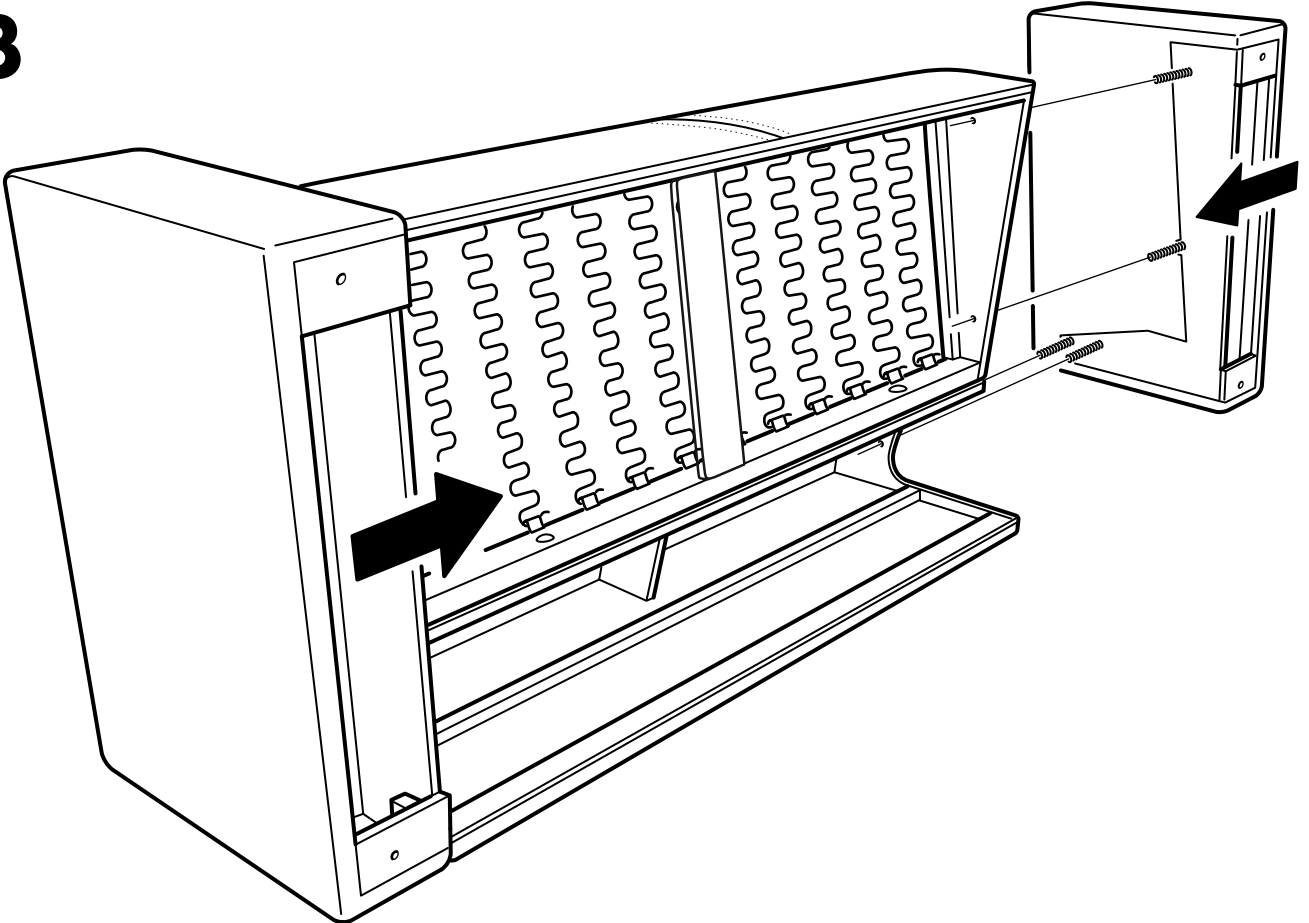

4

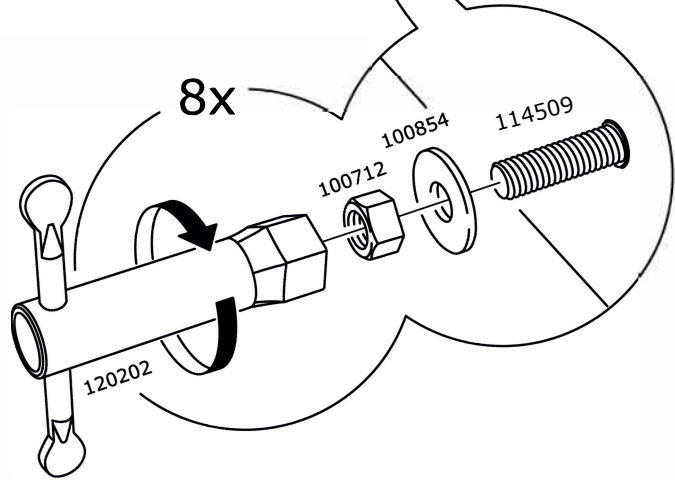
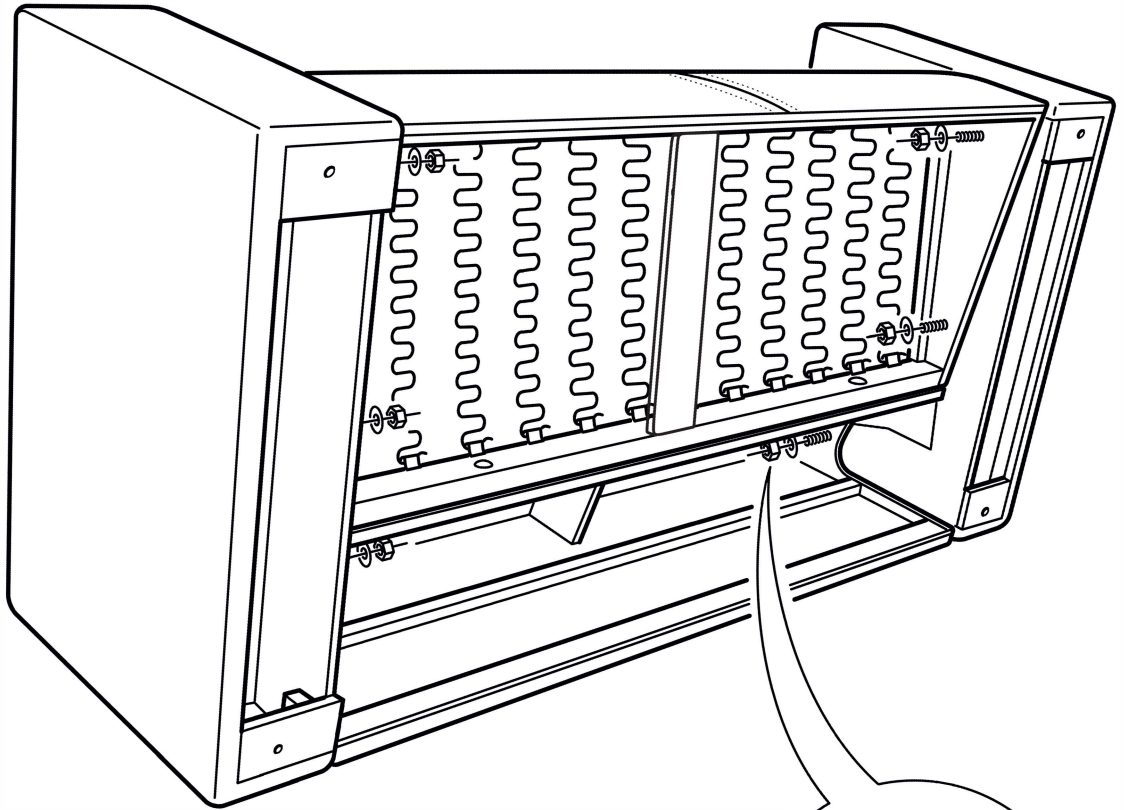

5

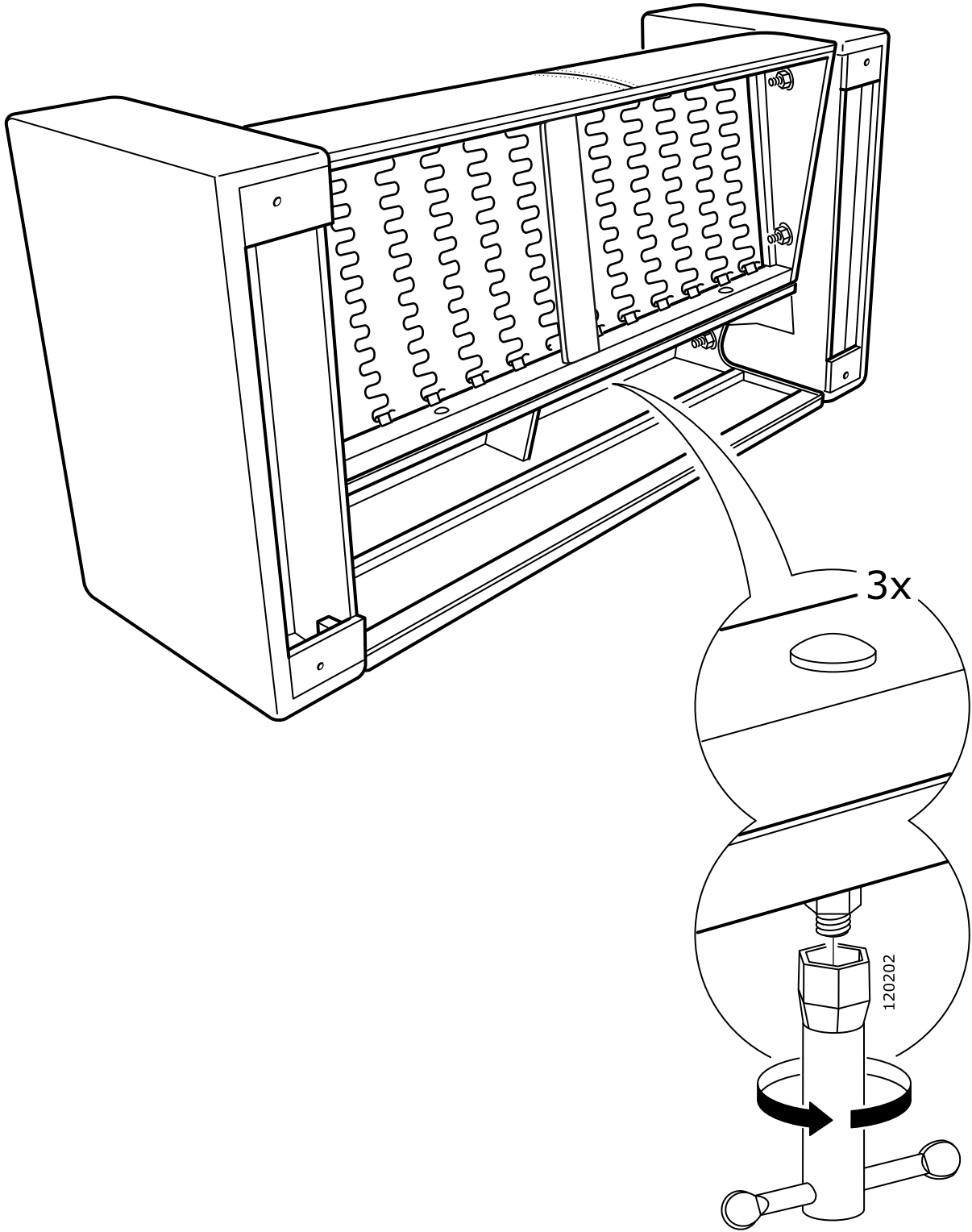

6

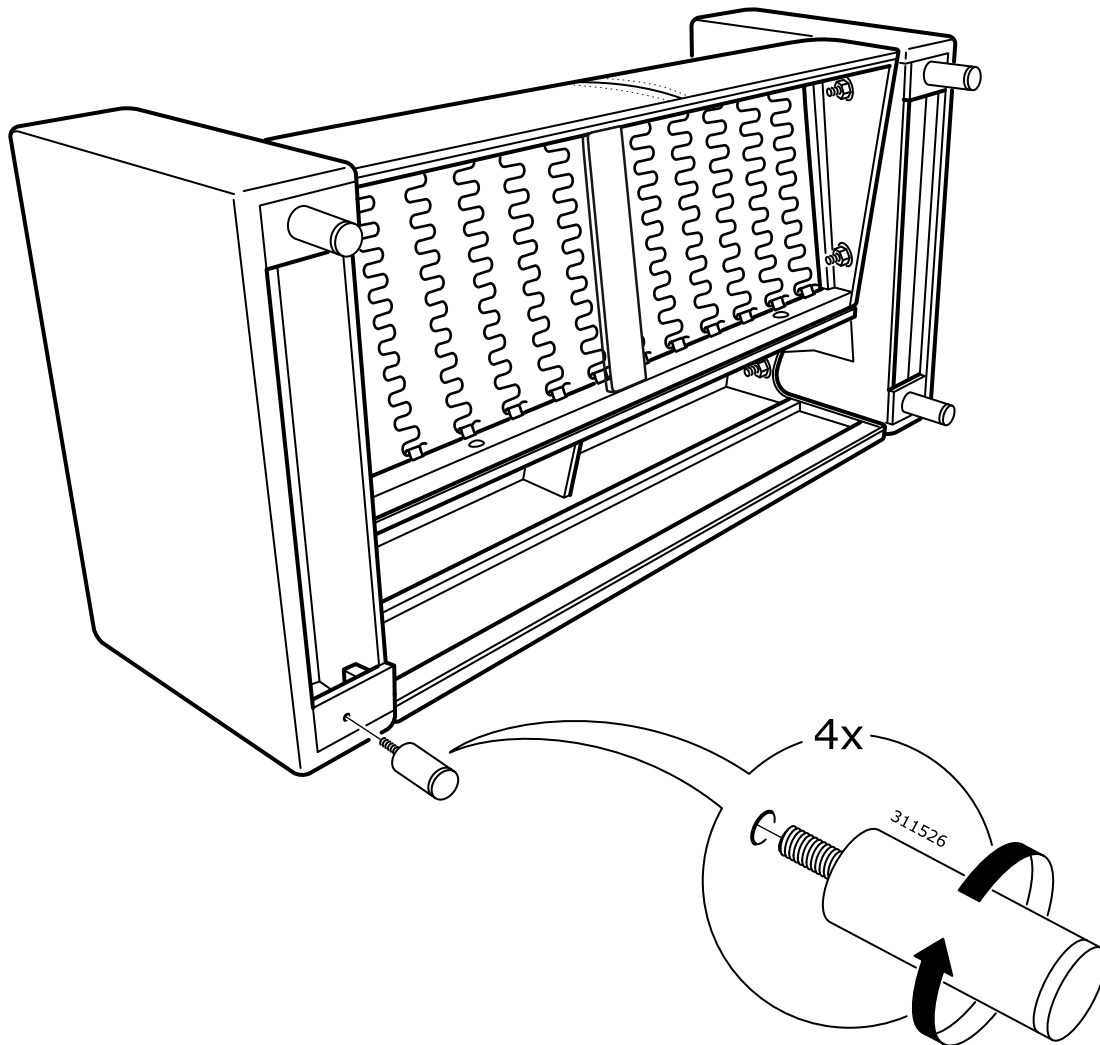

7

